

Prénom : _____

Date : _____



Se repérer dans le temps

Une journée

Découpe et colle les étiquettes.

Le soleil

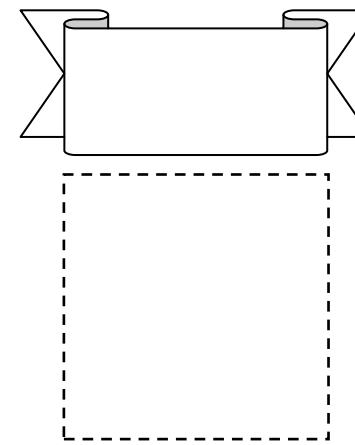
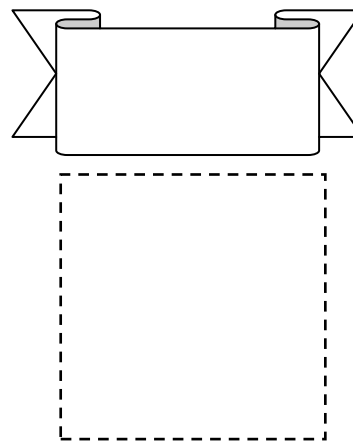
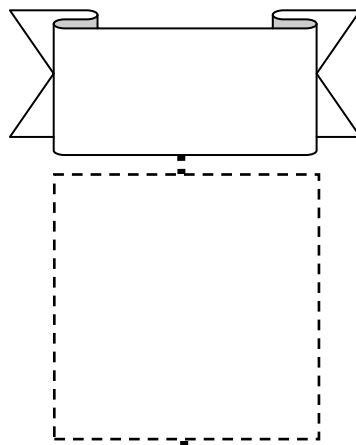
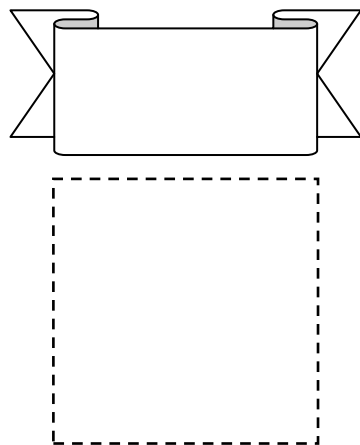



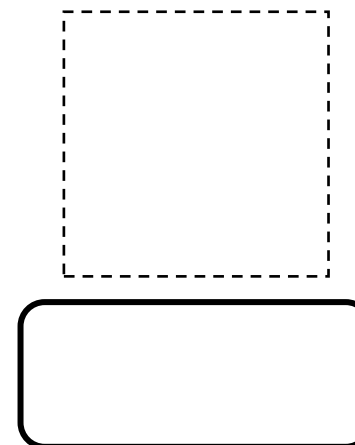
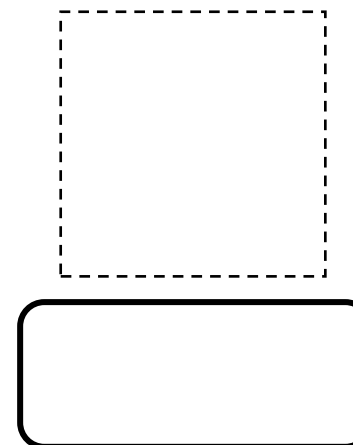
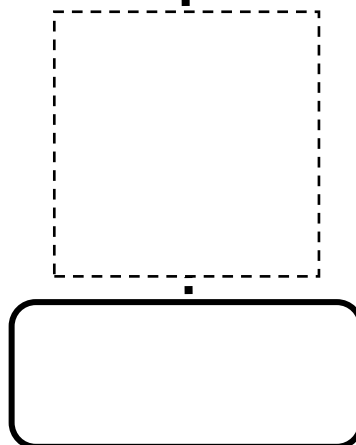
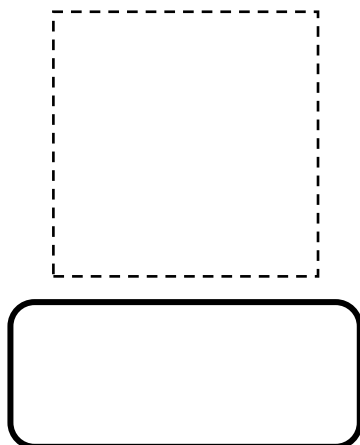



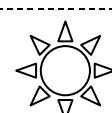
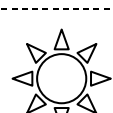

Les repas

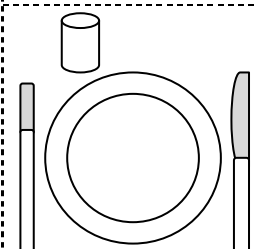
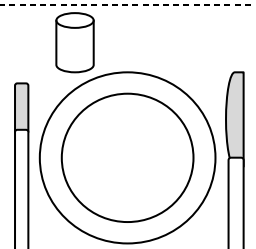
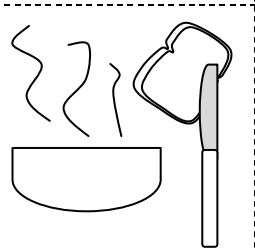
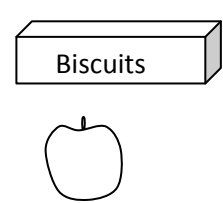

Etiquettes pour deux élèves

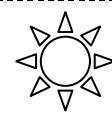
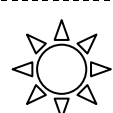
Bien couper selon les pointillés (attention à la ligne d'horizon !)

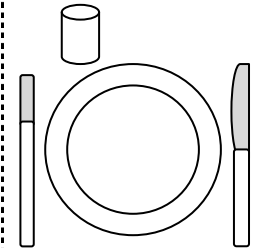
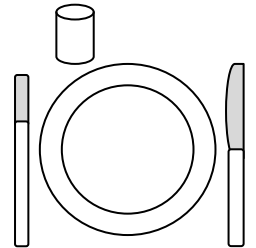
MIDI	SOIR	MATIN	APRES-MIDI
			
			
Dîner	Goûter	Petit déjeuner	Déjeuner

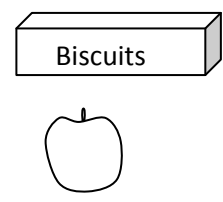
MIDI	SOIR	MATIN	APRES-MIDI
			
			
Dîner	Goûter	Petit déjeuner	Déjeuner